

SF0612



- Premium charcoal
- RC48 virgin granular carbon
- Deep carbon bed
- High open area
- Large air flow
- For seamless operation pair these filters with all SENSDAR EC fans

GENERAL DATA

Model	SF0612
Duct Opening	6inch/153mm
Length	12inch/314mm
Air Flow	400CFM/680M ³ H
Medium	Premium Charcoal
Grade	RC-48
Carbon Bed	1.8inch/45mm
Carbon Weight	4.2Kg
Total Weight	5.9Kg
Filter Type	Pre-filter
Housing Material	Cold rolled steel

ATTACHMENT OPTIONAL

Prefiltered cotton • black

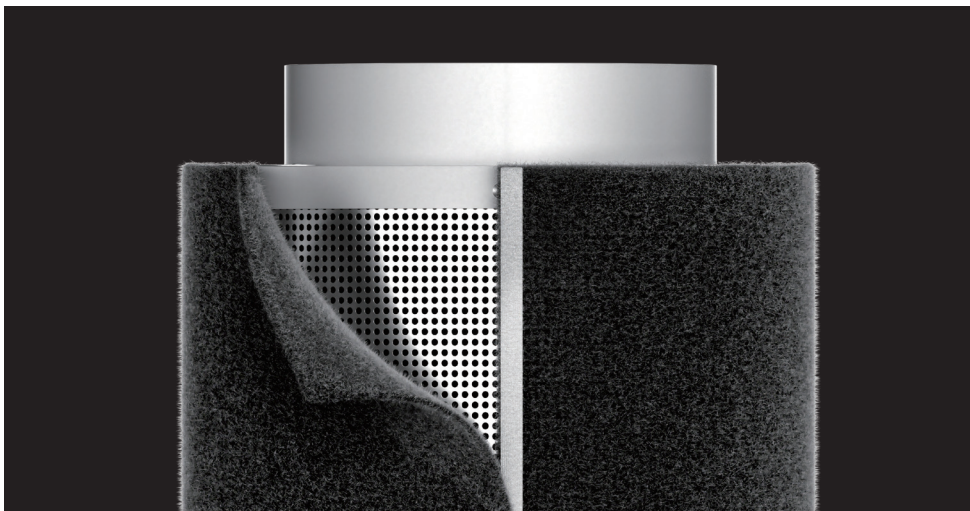

Prefiltered cotton • white

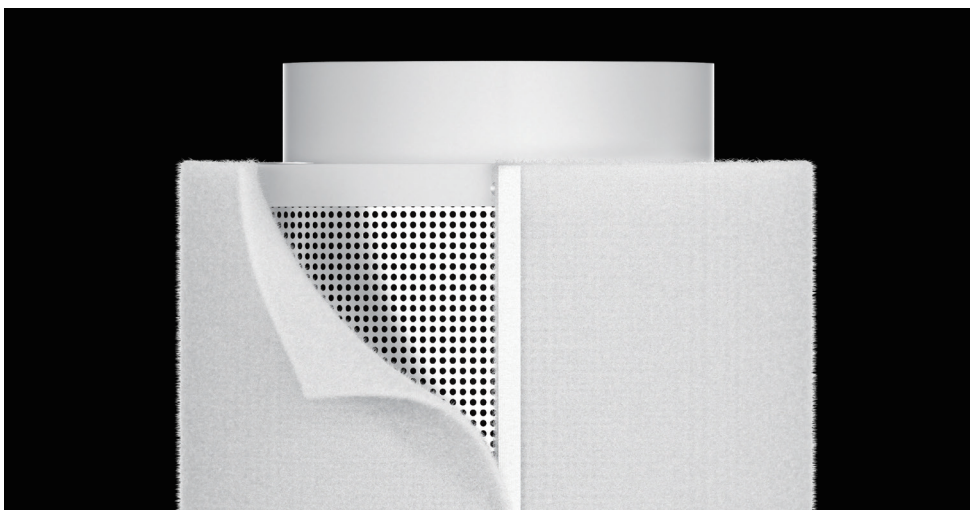

DIMENSION DRAWING

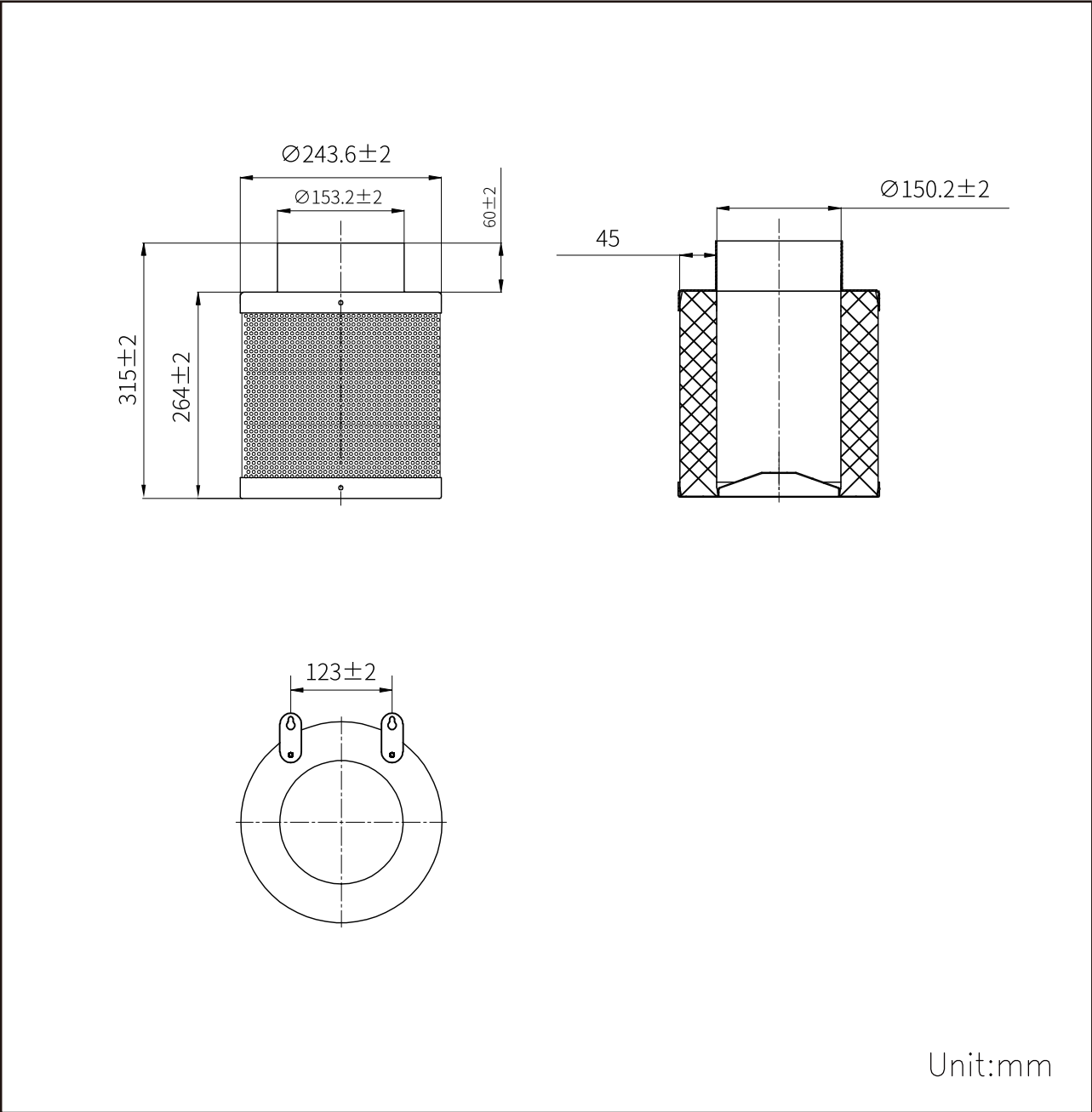

ADAPTABLE MODEL

■ SE-A150Z



■ SE-A150



■ SE-A150J

