

SE-A150J



- Rotatable spring Anti-Vibration design
- Metal painted Leak-Free acoustic housing
- Hanging brackets ensure more safety and no swing after installation
- High density acoustic foam
- Certified: CE,UKCA,ETL,SAA,PSE,G-mark

GENERAL DATA

| | |
|---------------|----------------------------|
| Model | SE-A150J |
| Fan Size | 6inch/150mm |
| Net Weight | 5.0KG |
| Rated Voltage | 110~120VAC/220~240VAC |
| Max. Power C | 40W |
| Frequency | 50/60Hz |
| Max. Speed | 5000RPM |
| Max. Airflow | 350CFM/594M ³ H |
| Max. Static P | 51mmH ² O/500Pa |
| Max.Noise L | 50dBA |
| IP Rating | IPX4 |
| Housing | Painted Metal |
| Motor Type | EC Motor |

PQ Curve

| Name | Value | Unit |
|-------------|-------|-------------------|
| Volume flow | 594 | M ³ /H |
| Pressure | 500 | Pa |

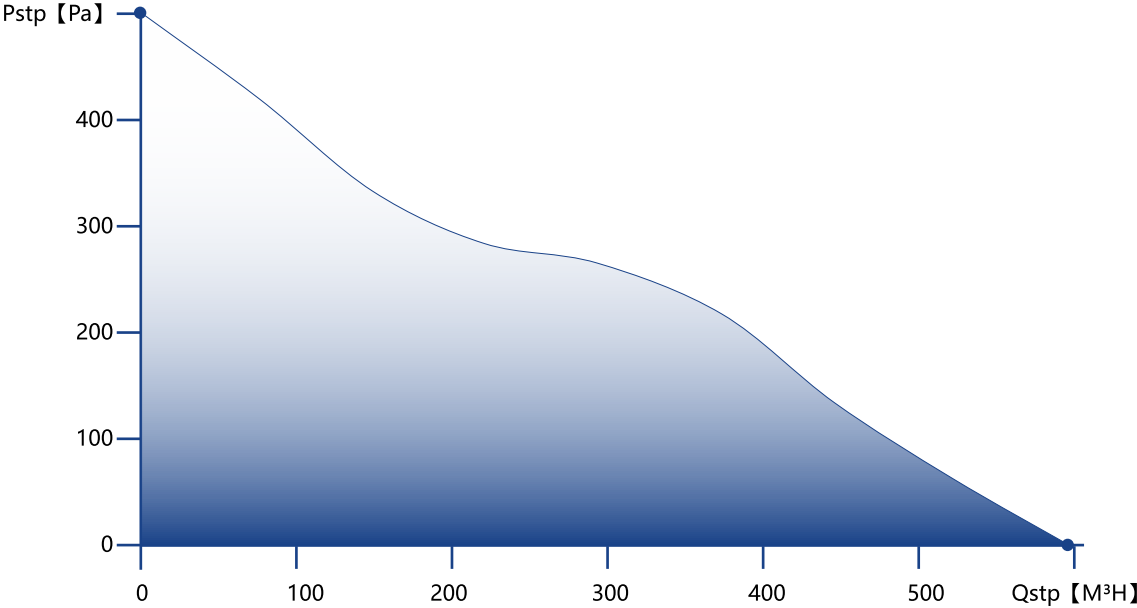

DIMENSION DRAWING

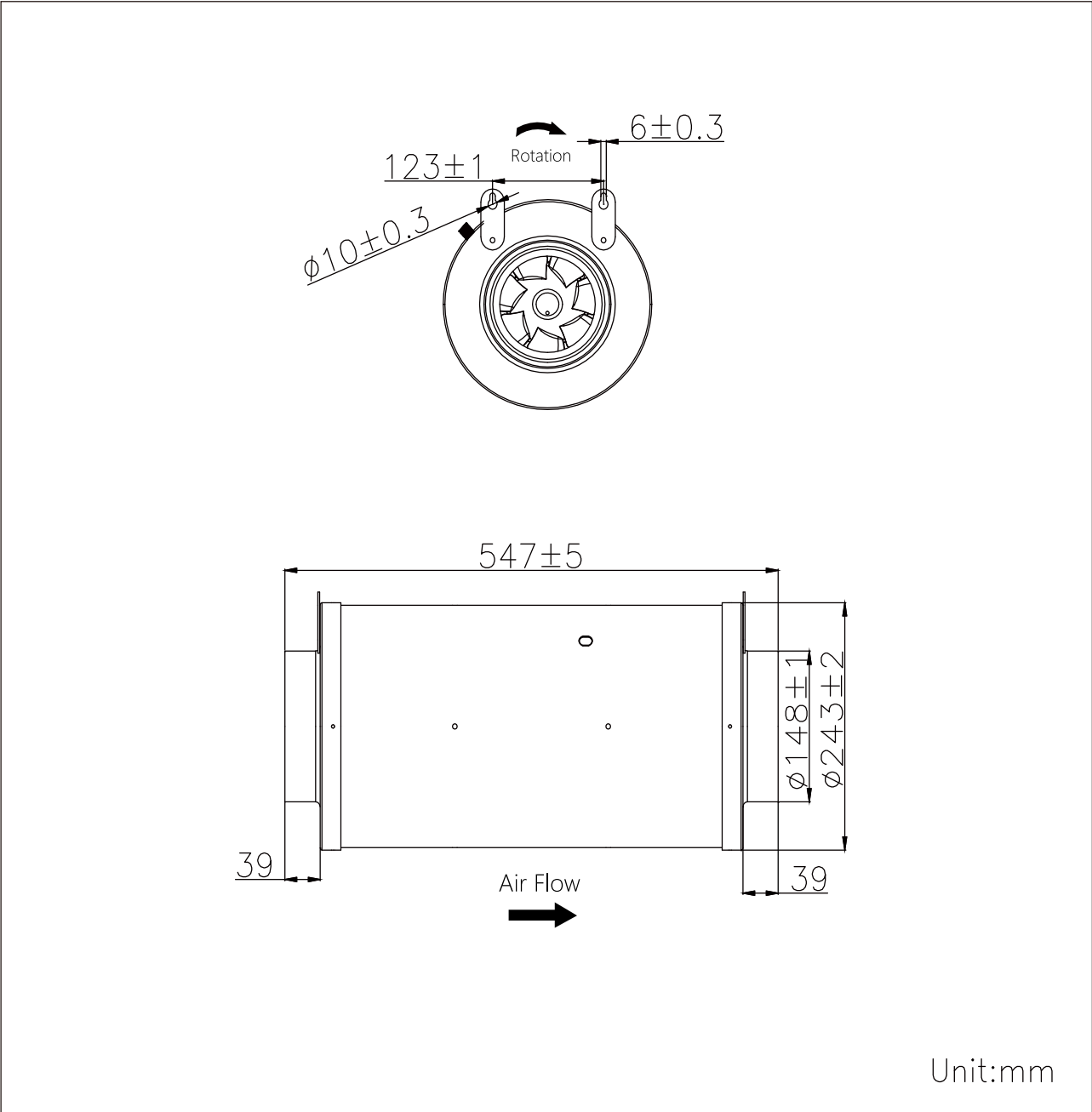

DIY 4-PINS CONTROL

EC fan with Multiple Speed Control Signals is packed with a DIY 4 pins connection cable, please refer to the diagram below.

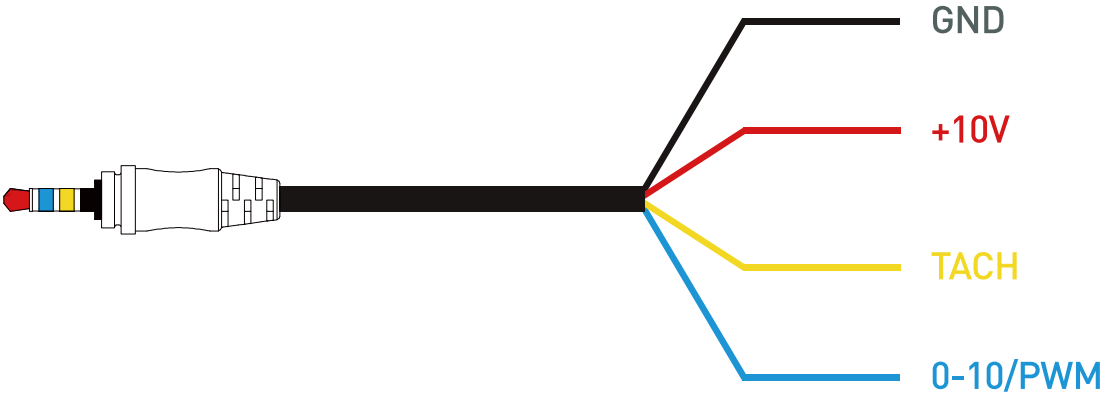

Speed Control via 0-10V

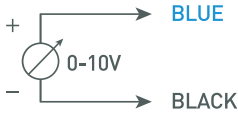

Max.Speed

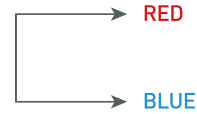

Speed Control via PWM

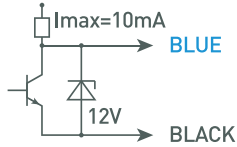

Speed Control via POT



ACCESSORIES

■ Smart EC fan controller pro



■ Temperature controller



■ Wall mounted controller



■ Wireless remote with receiver



■ Wall mounted controller (US)



■ Varibale speed controller



■ Extension Control cable



■ DIY Speed Control Cable



■ 3 Pins Controller Adaptor



■ RJ45 Controller Adaptor



HANG INSTALLATION

1. Mark the screw position on the wall

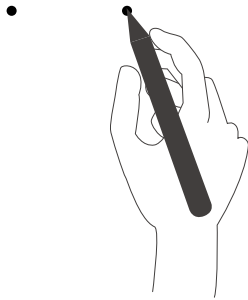

2. Punch holes in the wall



3. Tighten the hook



4. Hook the lug on the fan

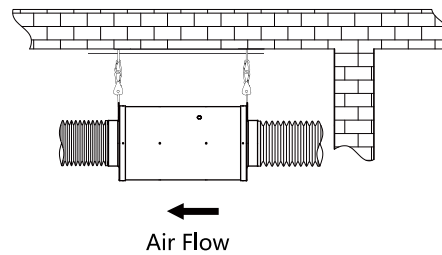

5. Connect the speed control to the fan and make sure the connection is in place and fastened

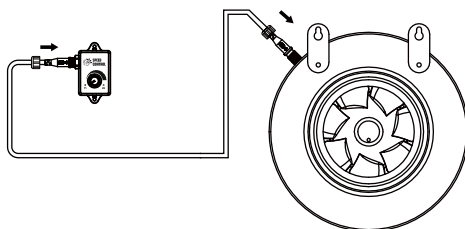

6. Power up the fan

