

SE-A250



- Innovative, high efficient mixed flow fan
- Jet-engine design, precisely calibrated, aerodynamics refined through CFD optimization
- Eco-watt technology, 3-phase, 6-pole brushless motor
- Certified: CE,UKCA,ETL,SAA,PSE,G-mark

GENERAL DATA

Model	SE-A250
Fan Size	10inch/250mm
Net Weight	3.0KG
Rated Voltage	110~120VAC/220~240VAC
Max. Power C	150W
Frequency	50/60Hz
Max. Speed	3200RPM
Max. Airflow	1065CFM/1808M ³ H
Max. Static P	52mmH ² O/510Pa
Max.Noise L	65dBA
IP Rating	IPX4
Housing	Painted Metal
Motor Type	EC Motor

PQ Curve

Name	Value	Unit
Volume flow	1808	M ³ /H
Pressure	510	Pa

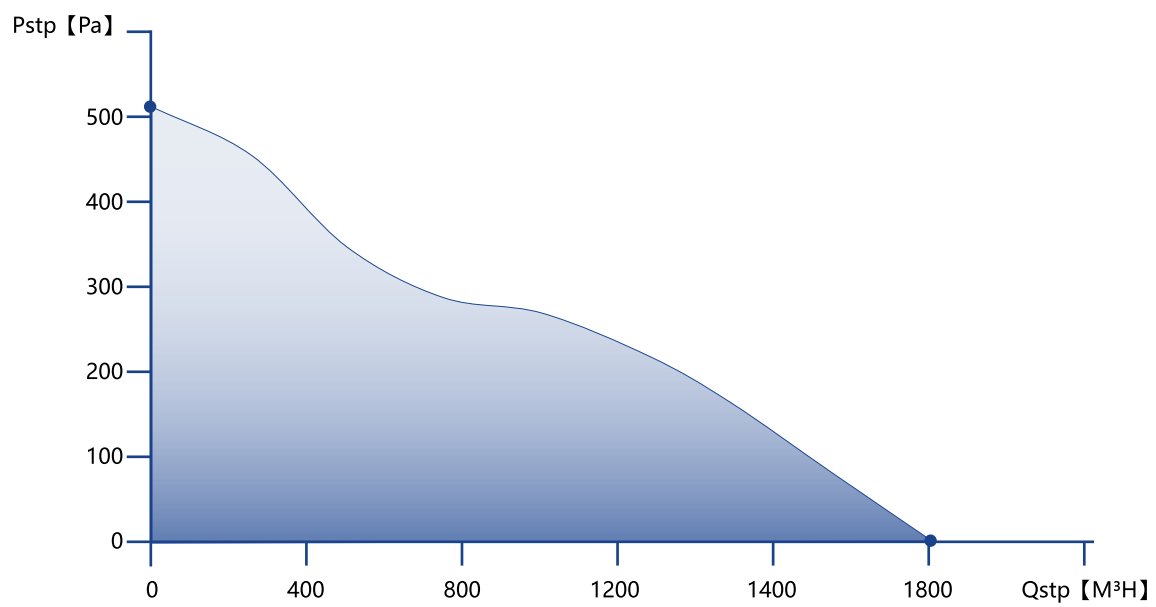

DIMENSION DRAWING

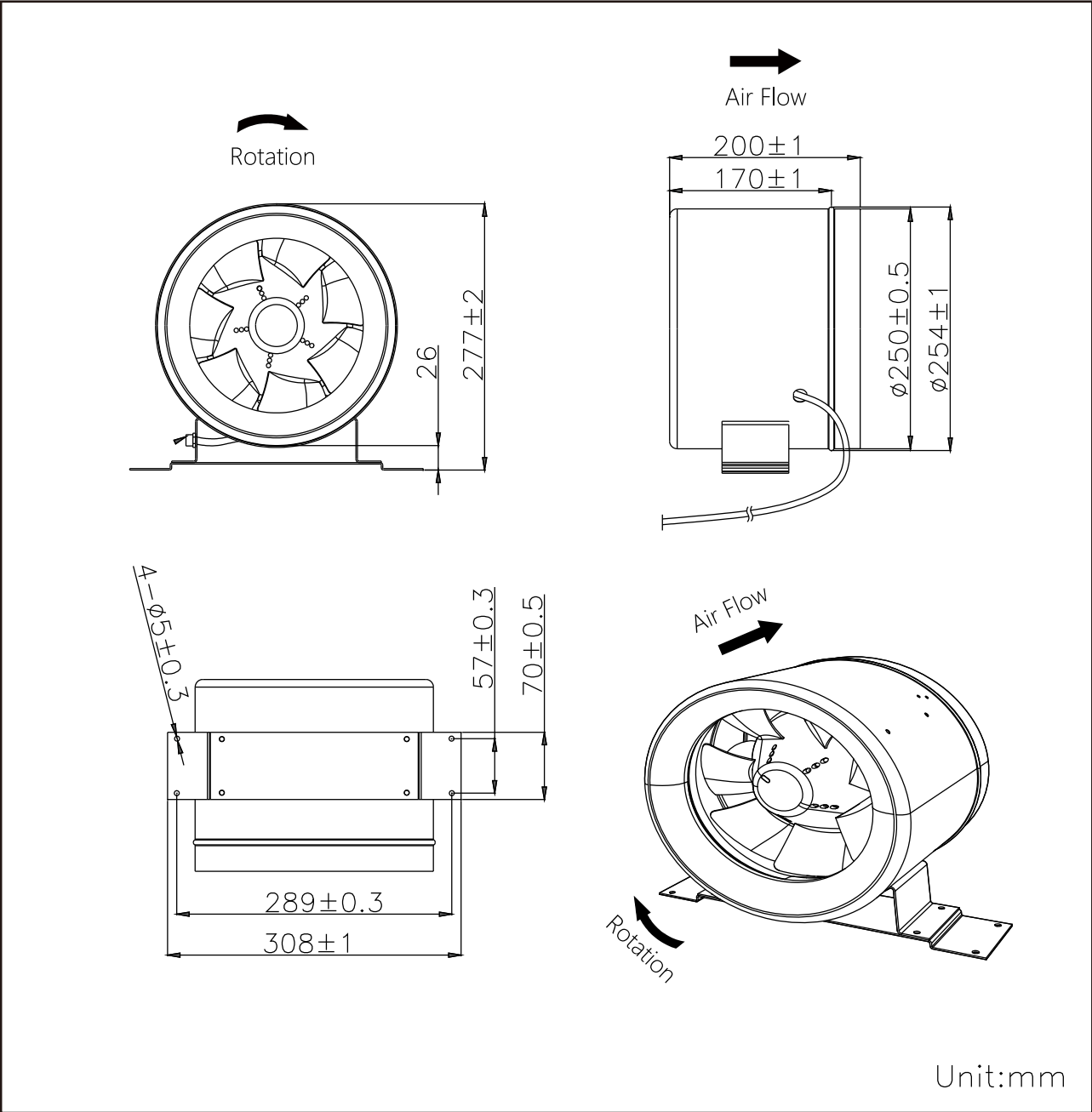

DIY 4-PINS CONTROL

EC fan with Multiple Speed Control Signals is packed with a DIY 4 pins connection cable, please refer to the diagram below.

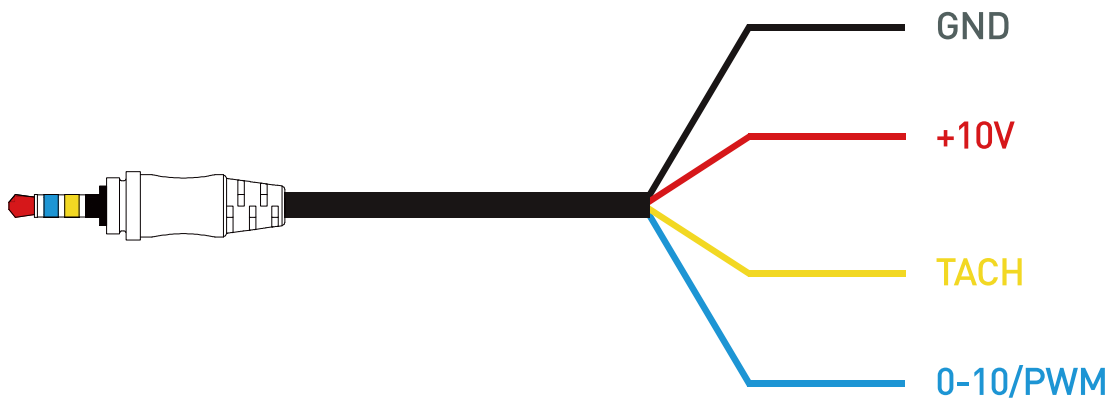

Speed Control via 0-10V

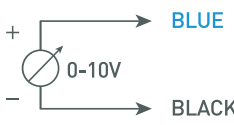

Max.Speed

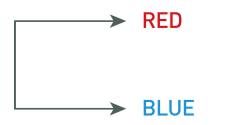

Speed Control via PWM

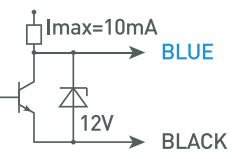

Speed Control via POT



ACCESSORIES

■ Smart EC fan controller pro



■ Temperature controller



■ Wall mounted controller



■ Wireless remote with receiver



■ Wall mounted controller (US)



■ Varibile speed controller



■ Extension Control cable



■ DIY Speed Control Cable



■ 3 Pins Controller Adaptor



■ RJ45 Controller Adaptor



WALL MOUNTED INSTALLATION

1. Mark the screw position on the wall

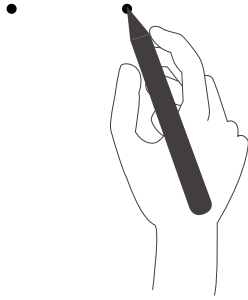

2. Punch holes in the wall



3. Screw the fan onto the wall

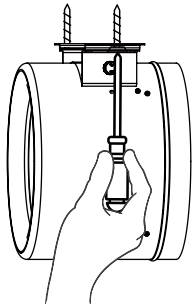

4. Connect the ducts on two sides with clamps

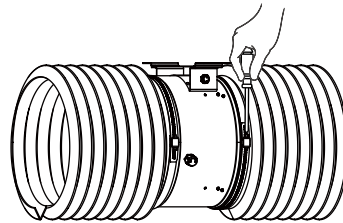

5. Connect the speed control to the fan and make sure the connection is in place and fastened

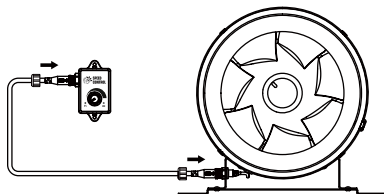

6. Power up the fan

