

EC 92x92x38mm



- Innovative, high efficient mixed flow fan
- Jet-engine design, precisely calibrated, aerodynamics refined through CFD optimization
- Eco-watt technology, 3-phase, 6-pole brushless motor
- Certified: CE,UKCA,ETL,SAA,PSE,G-mark

GENERAL SPECIFICATIONS

Insulation:	Class B
Material:	Impeller & Frame: Plastic (UL94V-0)
Lead Wire:	UL Type
Mode of operation:	S1
Operation Temperature:	-10°C-70°C, 35%-85%RH
Storage Temperature:	-40°C-80°C, 35%-85%RH
Available Features:	IP68 / PWM / FG&RD / Thermal control / Autoresart / Slow startup

SPECIFICATIONS

Model	Bearing System		Rated Voltage	Frequency	Operation Voltage	Rated Current	Power	Rated Speed	Air Flow	Air Pressure	Noise Level	Weight
	Ball	Sleeve	VAC	Hz	VAC	A	W	RPM	CFM	mmH ₂ O	dBA	g
SE9238HX	●	●	115/230	50/60	98~264	0.14/0.07	7	3500	77.4	8.3	37	175
SE9238MX	●	●				0.10/0.05	5	3000	67.9	6.2	33	
SE9238LX	●	●				0.06/0.03	4	2500	56.9	4.4	29	

DIMENSIONS DRAWIN

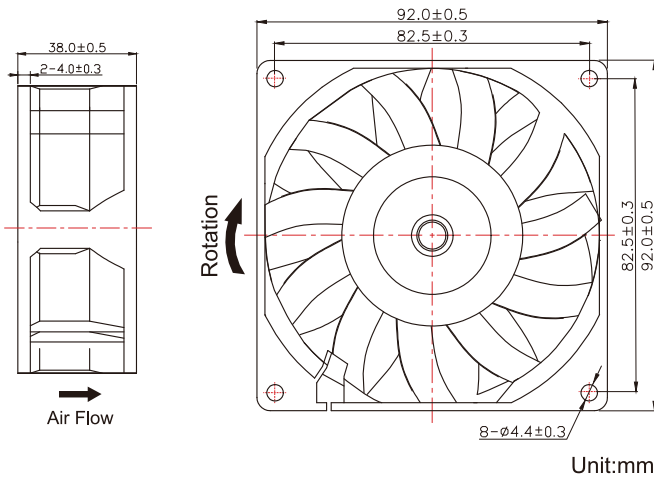

P&Q CURVE(AT RATED VOLTAGE)

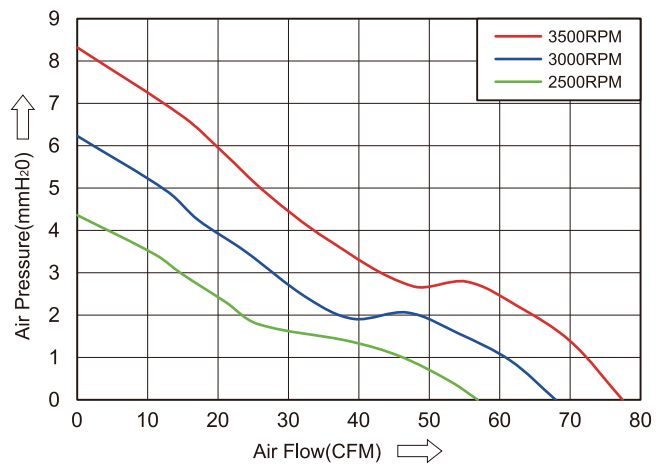

Note:

- *All readings are typical values at rated voltage.
- *The noise value is the measured value at the distance of 1 meter from the fan inlet
- *Specifications are subject to change without prior notice.
- * "X" in model list can be B, S, and C, meaning Dual Ball Bearing, Sleeve Bearing and 1 Ball 1 Sleeve Bearing