

SF1224

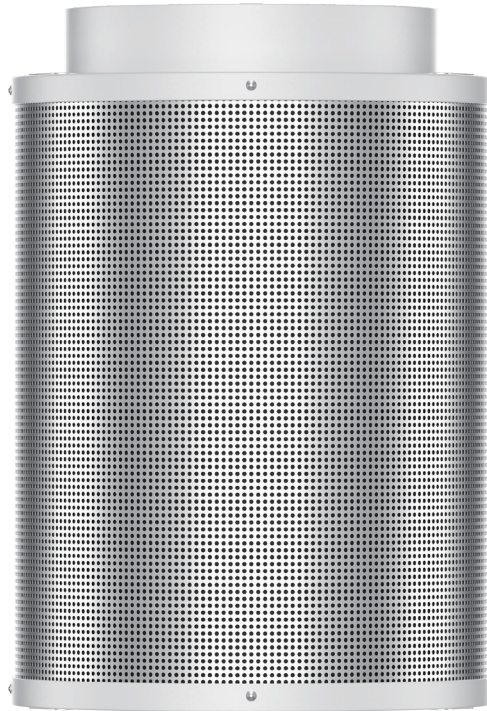

- Premium charcoal
- RC48 virgin granular carbon
- Deep carbon bed
- High open area
- Large air flow
- For seamless operation pair these filters with all SENSDAR EC fans

GENERAL DATA

Model	SF1224
Duct Opening	12inch/319mm
Length	24inch/615mm
Air Flow	1400CFM/2378M ³ H
Medium	Premium Charcoal
Grade	RC-48
Carbon Bed	1.8inch/45mm
Carbon Weight	19.2Kg
Total Weight	25.2Kg
Filter Type	Pre-filter
Housing Material	Cold rolled steel

ATTACHMENT OPTIONAL

Prefiltered cotton • black

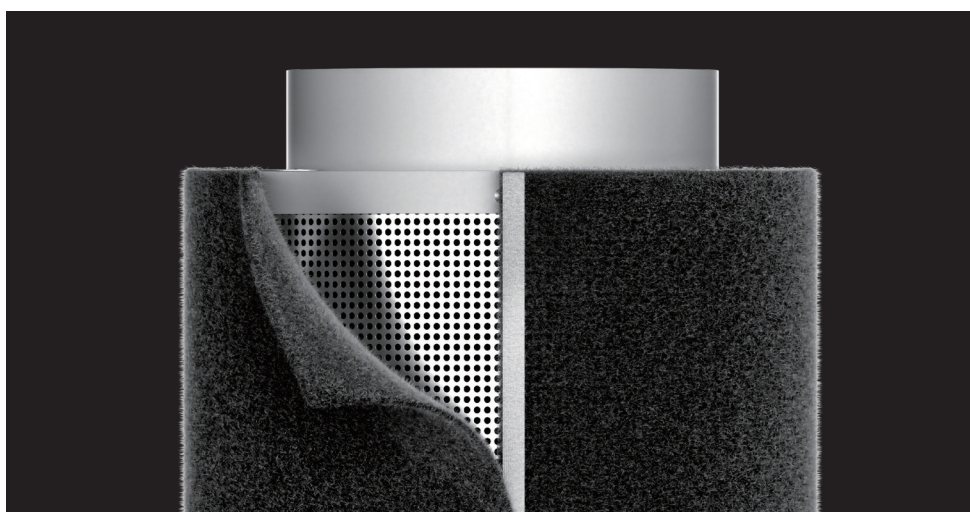

Prefiltered cotton • white



DIMENSION DRAWING

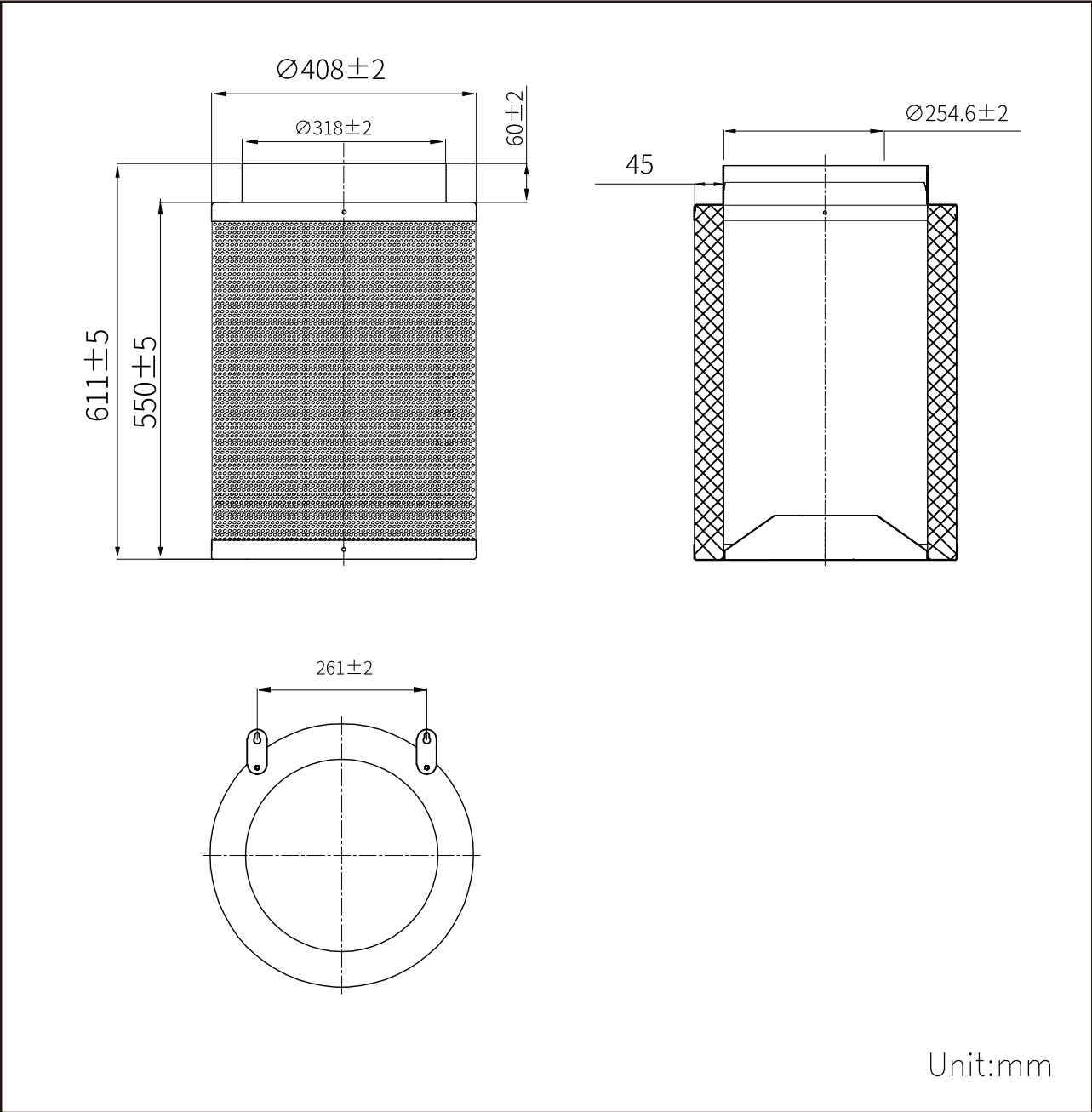

ADAPTABLE MODEL

■ SE-A315Z



■ SE-A315J

