

## SE-A200



- Innovative, high efficient mixed flow fan
- Jet-engine design, precisely calibrated, aerodynamics refined through CFD optimization
- Eco-watt technology, 3-phase, 6-pole brushless motor
- Certified: CE,UKCA,ETL,SAA,PSE,G-mark

## GENERAL DATA

Model	SE-A200
Fan Size	8inch/200mm
Net Weight	2.5KG
Rated Voltage	110~120VAC/220~240VAC
Max. Power C	75W
Frequency	50/60Hz
Max. Speed	3800RPM
Max. Airflow	710CFM/1205M <sup>3</sup> H
Max. Static P	53mmH <sup>2</sup> O/520Pa
Max.Noise L	61.6dBA
IP Rating	IPX4
Housing	Painted Metal
Motor Type	EC Motor

# PQ Curve

Name	Value	Unit
Volume flow	1205	M <sup>3</sup> /H
Pressure	520	Pa

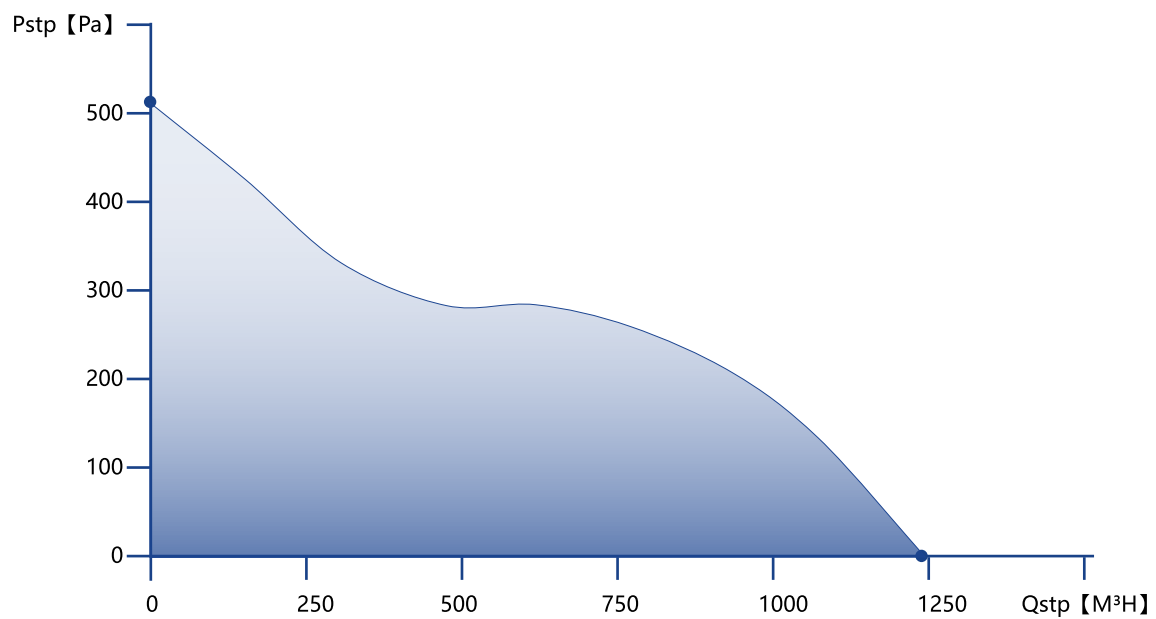

# DIMENSION DRAWING

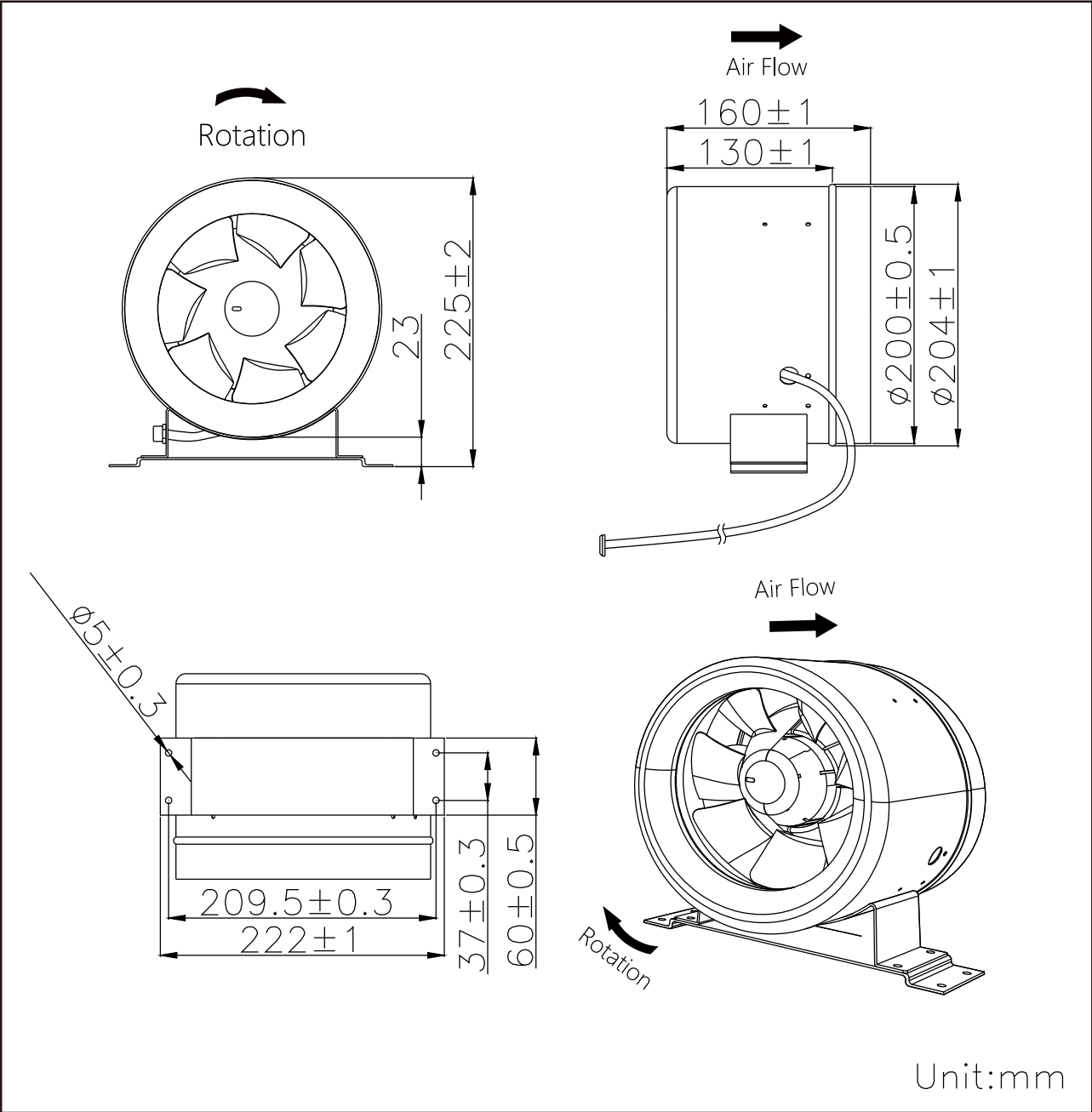

# DIY 4-PINS CONTROL

EC fan with Multiple Speed Control Signals is packed with a DIY 4 pins connection cable, please refer to the diagram below.

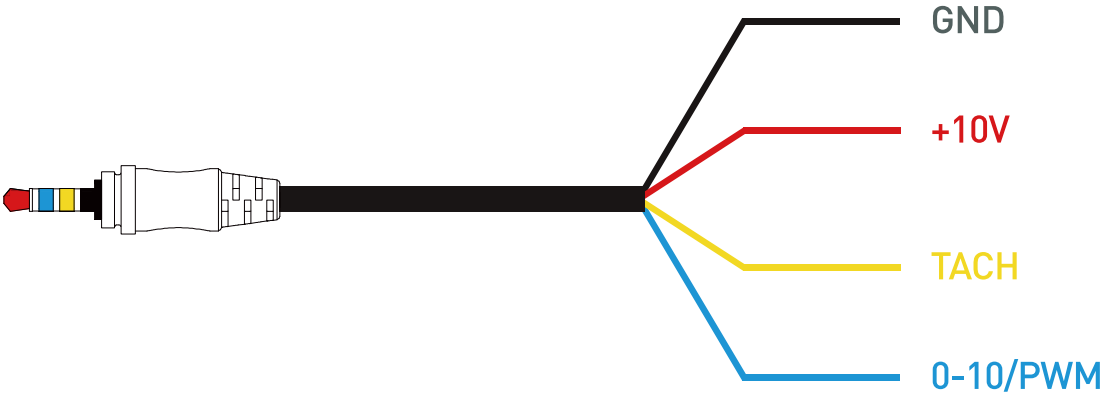

**Speed Control via 0-10V**

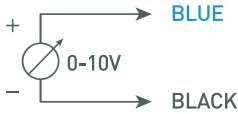

**Max.Speed**



**Speed Control via PWM**

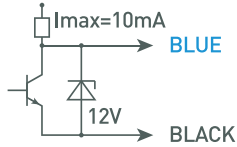

**Speed Control via POT**



# ACCESSORIES

■ Smart EC fan controller pro



■ Temperature controller



■ Wall mounted controller



■ Wireless remote with receiver



■ Wall mounted controller (US)



■ Varibale speed controller



■ Extension Control cable



■ DIY Speed Control Cable



■ 3 Pins Controller Adaptor



■ RJ45 Controller Adaptor



# WALL MOUNTED INSTALLATION

1. Mark the screw position on the wall

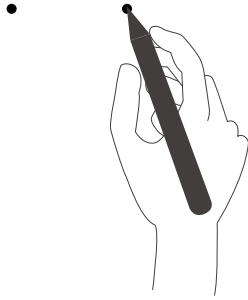

2. Punch holes in the wall



3. Screw the fan onto the wall

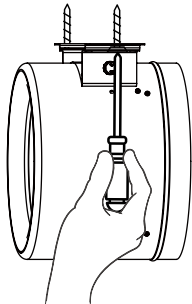

4. Connect the ducts on two sides with clamps

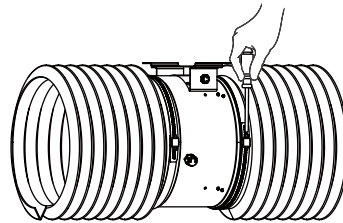

5. Connect the speed control to the fan and make sure the connection is in place and fastened

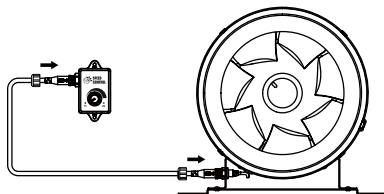

6. Power up the fan

